

# R Recommendations



## Overview

This section provides preliminary recommendations for the alignment of the proposed Ecusta Rail Trail. Recommendations include proposals for the trail surface, support facility locations, roadway crossing treatments, and structural improvements to bridges. Following an overview of each of these elements, a proposed phasing plan is provided, including a description, detailed map, and estimated cost for each phase. Finally, a summary of all estimated costs and benefits concludes this section.

## Alignment

### Trail Surface

Due to the multiple uses of the trail, a 12-foot wide asphalt trail with a two-foot wide shoulder is recommended. Specific design characteristics of the various trail types and circumstances are detailed in the Design Guidelines (Appendix D). The design guidelines - developed specifically for the Ecusta Rail Trail corridor - reflect the relevant national practices.

### Roadway Intersections

The rail corridor crosses many formal and informal roadways along its 20-mile length. There are seventy crossings in total, consisting of forty-five road crossings, ten driveway crossings, and

fifteen informal, unpaved crossings. Crossings occur in several ways. The majority are far enough from road intersections to be treated as mid-block crossings. Several are located adjacent to intersections, which come in the form of four-way, T, or Y arrangements. These crossings must be integrated into the design of the intersections while maintaining functionality for turning vehicles. One rail crossing is currently grade-separated.

Roadway crossings represent a key safety challenge for trail designers since drivers often do not expect to see bicyclists and pedestrians crossing mid-block or across streets onto which they are turning. A combination of signals and traffic controls can increase driver awareness of trail crossings. Similarly, pedestrians and cyclists travelling on trails may not notice upcoming crossings without proper signals along the trail itself. Controls in the form of signs or signals are therefore recommended along both the trail and the roadway at all crossings.

Crossing treatments are recommended in this chapter based on both trail and roadway characteristics. Key roadway factors influencing the selected treatment include the posted speed limit, traffic volume, line of sight, street width, and intersection configuration. The selected treatments provide a starting point for design, but they should be examined in greater detail as

## Contents of Section Six:

Overview

Alignment

Structural Improvements

Costs

Phasing Plan

Support Facilities

Summary of Estimated Costs and Benefits



part of the design and implementation of each trail segment. Details about specific intersection treatment types and controls are provided in Appendix C.

## *Railroad Structural Improvements*

### **Overview**

Structural improvements are provided on the following pages as recommendations for renovations, repairs, and reuse for all bridge structures along the Ecusta Rail Trail. Bridge decking and railing best practices are identified, as well as potential costs associated with any upgrades or renovations that may be required.

### **Bridges**

Since non-destructive bridge inspection techniques for detecting and assessing structural integrity were used for this planning study, SW+A and Fuller Consulting Engineers recommend a full structural analysis - including of dye penetrate tests, magnetic particle tests, ultrasonic scanning, and acoustic emission monitoring - prior to any final recommendations or construction activities. SW+A and Fuller Consulting Engineers further recommend drilling and measuring bents, ballasts, and other materials based on predetermined locations likely to harbor decay (i.e. near drift pins, bolts, etc.) to ensure structural stability.

The existing railway has 16 bridges along its current path. These bridges have not been maintained since the closing of the rail line and in some cases show signs of extreme decay. It would be prudent to perform an individual, detailed, structural analysis of each bridge once the final trail path is established. This would

allow recommendations to be made, along with any required drawings for specific defects noted. While several of the existing bridge structures have signs of general decay, they may indeed be capable of safely supporting the pedestrian use of the proposed trail. The railway trestles and bridges are designed for a substantially greater load than that inflicted by pedestrian traffic. It should be noted that a conversion back to a railway line would cost much more (See Appendix E for more information on these costs). This would be due to the fact that several of the bridges would already require considerable cost to rehabilitate for rail traffic if put back into service immediately.

### **Ballasts**

The referenced existing railway is typically composed of a gravel base with cross ties embedded and supporting the rails. Typically, when a rails-to-trails system is employed, the existing rails and cross tie supports are removed and the existing gravel is utilized as a base material for the new surface. It would be expected that, with the substantial loading the existing railway base would have received over its life, no additional remediation would be required to establish a base for the proposed trail. However, should the proposed trail be required to return to rail service in the future, a complete bearing and soil analysis should be performed along the entire length to determine if any remediation would be required to establish a suitable base for the installation of new cross ties and rails based on the required load and allowable deflection criteria that is in place at the time of conversion.

### **Recommendations**

#### **Deck and Superstructure:**

Guardrails and rails are to be removed prior to pedestrian bridge construction. Severely

deteriorating ties and ties causing shifts or deflection in the overall alignment should be replaced. Girders, when deteriorated deeper than 1", shall be replaced. Minor weathering and girders noted in satisfactory condition should be monitored for further deterioration.

Decking (2"x8") shall be slip resistant and affixed to structural timbers (4"x4"). Tie downs (6"x6") shall be placed to affix post (4"x4"), square pickets (1"), and rub rails (2"x6") to existing structural supports. See typical pedestrian bridge section and imagery support.

**Substructure:**

Back walls and wing walls with undermining will require further soil test to determine bearing pressure and compaction of residual soils. Visual analysis presumes Portland cement slurry in lieu of sand. Deflecting timber piles should be supported with additional timber cross braces. Timber caps with less than 1" of deterioration should be monitored for further decay. Metal sheathing should be replaced where severe corrosion has resulted in decreased structural integrity. In other instances, painting of all exposed metal will increase the life span. Replace all wood shims where applicable. Trash, debris, and vegetative

Figure 6.1 – Typical Trail Cross-Section at Bridge

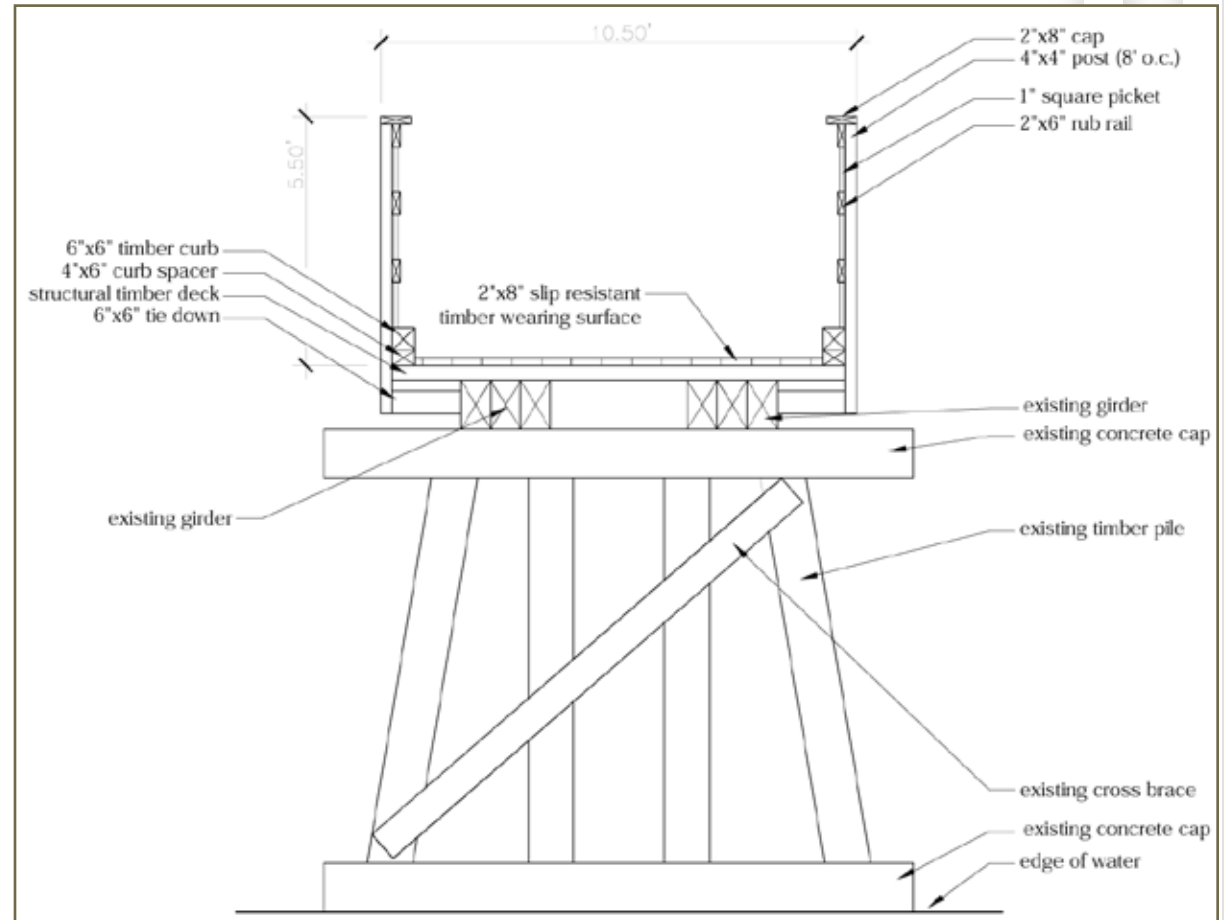





## Costs

### **Opinion of Probable Cost Associated with Bridge Improvements**

Bridge improvement costs can vary due to a variety of factors. The following preliminary cost analysis is a general guideline for the purpose of estimating trail costs. More detailed cost estimation should be performed at other points in the trail implementation process.

Table 6.1 shows general costs for elements typically included in bridge improvement projects. These unit costs are used to develop overall costs for each type of trail.

*Table 6.1 – Unit Cost for Pedestrian Bridge Improvements*

BRIDGE ELEMENT	UNIT	PRICE RANGE PER UNIT
Substructure Improvements	Linear Foot	\$48.00 - \$72.00
Superstructure Improvements	Linear Foot	\$48.00 - \$72.00
Deck and Rail Construction	Linear Foot	\$500.00 - \$1200.00
Other Costs (drainage, signage, etc.)	-	10% of bridge cost
Preliminary Planning	-	1%-2% of bridge cost
Construction Documents	-	5% of bridge cost
Construction Services & Administration	-	3%-5% of bridge cost



### **Total Costs**

Total budget costs are provided for each phase. A summary of costs and benefits is provided at the end of this section. For detailed information on cost estimates, see Appendix E.

## Phasing Plan

There are 20 miles of trail proposed along the rail corridor. The corridor traverses two counties and three local municipalities, with 8 miles in Transylvania County and 12 miles in Henderson County. The phasing strategy proposed below represents realistic goals for project implementation, assuming there is regional support and cooperation. Regardless of available funds or willing parties, it is necessary to prioritize construction of the trail into functional segments of development.

The following criteria was used as a guide to prioritize segments of trail for development.:

- Point-to-point connections, to avoid trail “dead-ends”
- Service areas and population density

- Number of connections to public property and commercial areas
- Development costs

The criteria should be revisited when closer to implementation. It is important to note that the phasing plan for physical development is contingent upon the successful completion of two initial tasks: the acquisition of the Norfolk Southern corridor; and the assumption of responsibility for trail operations and maintenance by either a regional authority or an interim municipal or state agency. No public facilities can be developed until these two critical tasks have been completed.

The maps in this section show the recommended alignment and summarize improvements as recommended phases. Separate phasing plans are recommended for each county, beginning with

Henderson County.

Along with the phase extents, each map shows the existing railroad bridges and roadway crossings occurring in the phase. The cost estimates incorporate both of these elements. The railroad bridges are numbered corresponding to the structural assessment in Section Two, and the roadway crossings are numbered consistent with the crossing treatment recommendations provided in Appendix C. Treatment types designated on the phasing maps are explained further in Appendix C as well. Proposed vegetative screening and fencing are also shown on the phasing maps and incorporated into cost estimates. A summary of ownership of adjacent properties based on deed descriptions is also included in each phase, because of its use in negotiations with the railroad.

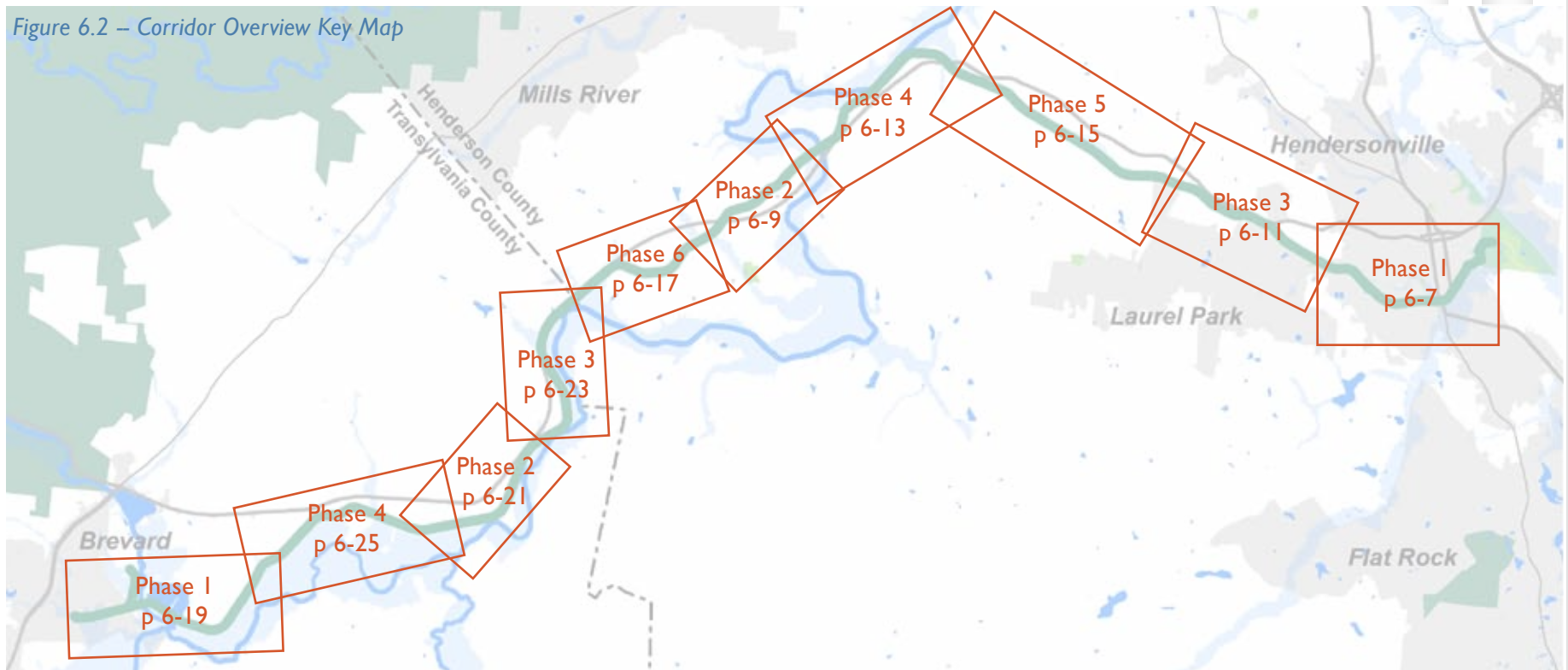

**HENDERSON COUNTY**

**PHASE I**

*Oklawaha Greenway in Jackson Park to Proposed Shared-Use Trailhead at Laurel Park*

**Description**

Phase I begins in Jackson Park connecting to the existing Oklawaha Greenway in Hendersonville and extends 2.36 miles west to the Town of Laurel Park at the town park. Dense downtown development will be served by Phase I. There is potential for sidewalk connections at multiple locations and state bicycle route connections at 5th Avenue, Israel Street, and 4th Avenue. Phase I will connect two jurisdictions. There are two trailheads proposed for Phase I.

**Trestles and Bridges**

There are two railroad bridges that would require additional, detailed structural analysis before proceeding the conversion to pedestrian use. The railway trestles and bridges were designed for a substantially greater load than that inflicted by pedestrian traffic, and - at a minimum - decking and railing is proposed to enhance safety. For more detail on the results of the engineers’ visual inspection of each bridge, please see the Existing Conditions section of this study.

**Social Issues**

Multiple neighborhoods exist along Phase I in Henderson County that will be impacted by the trail. Vegetative screening is proposed along these neighborhoods to provide separation between the trail and residential homes. A combination of vegetative evergreen screening and fencing along several industrial areas is also proposed to provide privacy for these adjacent property owners.

Adjacent landowners would also benefit from the trail. The proposed Rail Trail conversion would increase walking and bicycling opportunities for local residents who are using the existing network of state bicycle routes and sidewalks.

**Trailheads**

**Williams Street**

A new trailhead is proposed off Williams Street located on City of Hendersonville property, across from the downtown Operations Center. The existing, partially paved parking area along the tree line could be redesigned to offer 54 parking spaces to trail users and city employees, as well as additional sidewalk connections and landscape improvements. There is ample space to include a small visitor center with a restroom that could also be used as an educational building. The trailhead would provide a direct connection to the Ecusta Rail Trail.

**First Congregational Church Shared-Use Trailhead**

The existing First Congregational Church parking area off 5th Avenue West could be improved to provide an additional 12 parking spaces and become a shared-use trailhead for Ecusta Rail Trail users. Depending on the church’s needs, landscape improvements could be made to the property to provide buffering and other pedestrian enhancements. Overflow parking could be shared at the Town of Laurel Park’s Laurel Park, south of the church, if high visibility crossing facilities are provided across 5th Avenue West. Wayfinding signage will be installed to help orient trail users.

**Summary**

**Segment Length**

2.36 miles

**Total Budget Costs**

Trail Construction - \$1,057,263

Trail Design and Engineering Fees - \$105,726

Trailhead Construction - \$889,000

Trailhead Design and Engineering Fees - \$88,900

*Table 6.2 - Summary of Deed Descriptions*

DEED DESCRIPTION	NO. OF PARCELS	PERCENTAGE OF PARCELS
Description includes entire railroad	-	-
Described to center of railroad	18	23%
Description includes part of right-of-way	-	-
Description does not include railroad	60	77%
Total	78	



Figure 6.3 – Henderson County Phase I: Oklawaha Greenway in Jackson Park to Proposed Shared-Use Trailhead at Laurel Park

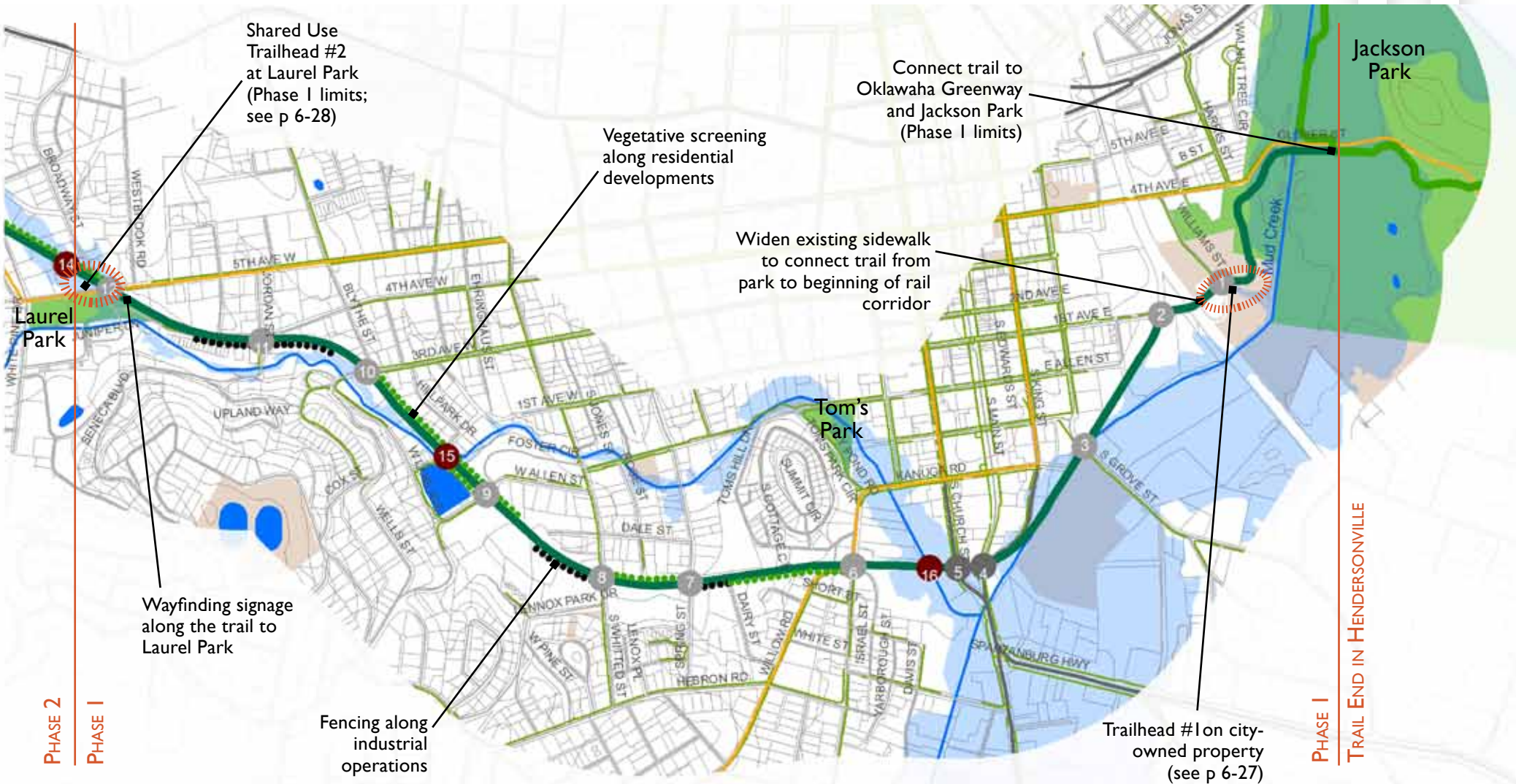

Corridor Overview Key Map

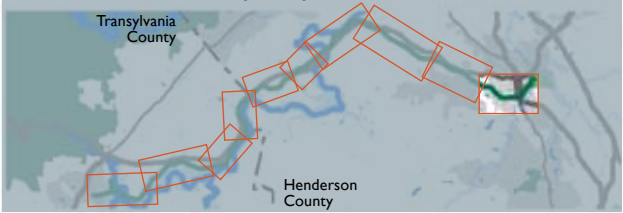

- Type 1 Crossing
- Proposed Rail Trail
- Sidewalk
- Conservation Land
- Type 2 Crossing
- Vegetative Screening
- Street
- Federal
- Type 3 Crossing
- Fencing
- Highway
- State
- Existing Railroad Bridge
- Existing Greenway
- Contour
- Local
- State Bike Route
- 100-Year Floodplain
- Public Property
- Water
- Parcel

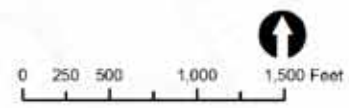

# PHASE 2

Etowah to EPONA property

### Description

Phase 2 provides two functional connections, totaling one mile in length. South of the Etowah Baptist Church on Etowah School Road, there is property owned by the church that could be converted to a shared-use trailhead. Phase 2 would extend east to the limits of the EPONA property, where a future large trailhead or equestrian facility is proposed. This segment would connect with the state bicycle route at McKinney Road and Etowah School Road. If a shared-use trailhead is constructed on Etowah School Road, there are opportunities to connect to Etowah Park and the school. A large trailhead/equestrian center would provide facilities for equestrian trail users, for which there is some demand.

### Trestles and Bridges

There are no bridge improvements proposed in Phase 2.

### Social Issues

Phase 2 is a more remote section of the Ecusta Rail Trail, and vegetative screening is recommended for the properties located along the corridor. Mileage markers and emergency phones will be important in this more rural section as the trail location becomes less obvious to trail users.

### Trailheads

#### Etowah School Road

The vacant property south of the Etowah Baptist Church could be improved to provide approximately 15 additional parking spaces for church parking and trail user parking. A small, open-air pavilion or restroom building could be provided with landscape enhancements. A 10-foot wide sidepath on the south side of Etowah School Road would connect users to the rail trail. Ultimately, the sidepath should extend east of the

trailhead to connect with the Etowah School so there is safe pedestrian access for walking and bicycling to school.

### Proposed Trailhead/Equestrian Center on EPONA property

A large tract of property owned by a willing private landowner has the potential to become a large equestrian center and trailhead that would support a significant number of trail users. Several open-air pavilions could be located among a network of natural surface trails, with parking for horse trailers and automobiles. Outside the floodplain, a stable and large visitor building could be constructed. Signage and pasture areas could enhance the trailhead. The property is located directly adjacent to the proposed Ecusta Rail Trail.

### Summary

#### Segment Length

1 mile

#### Total Budget Costs

Trail Construction - \$635,934

Trail Design and Engineering Fees - \$63,593

Trailhead Construction - \$1,265,000

Trailhead Design and Engineering Fees - \$126,500

Table 6.3 - Summary of Deed Descriptions

DEED DESCRIPTION	NO. OF PARCELS	PERCENTAGE OF PARCELS
Description includes entire railroad	1	2%
Described to center of railroad	27	64%
Description includes part of right-of-way	6	14%
Description does not include railroad	8	19%
Total	42	



Figure 6.4 – Henderson County Phase 2: Etowah to EPONA property

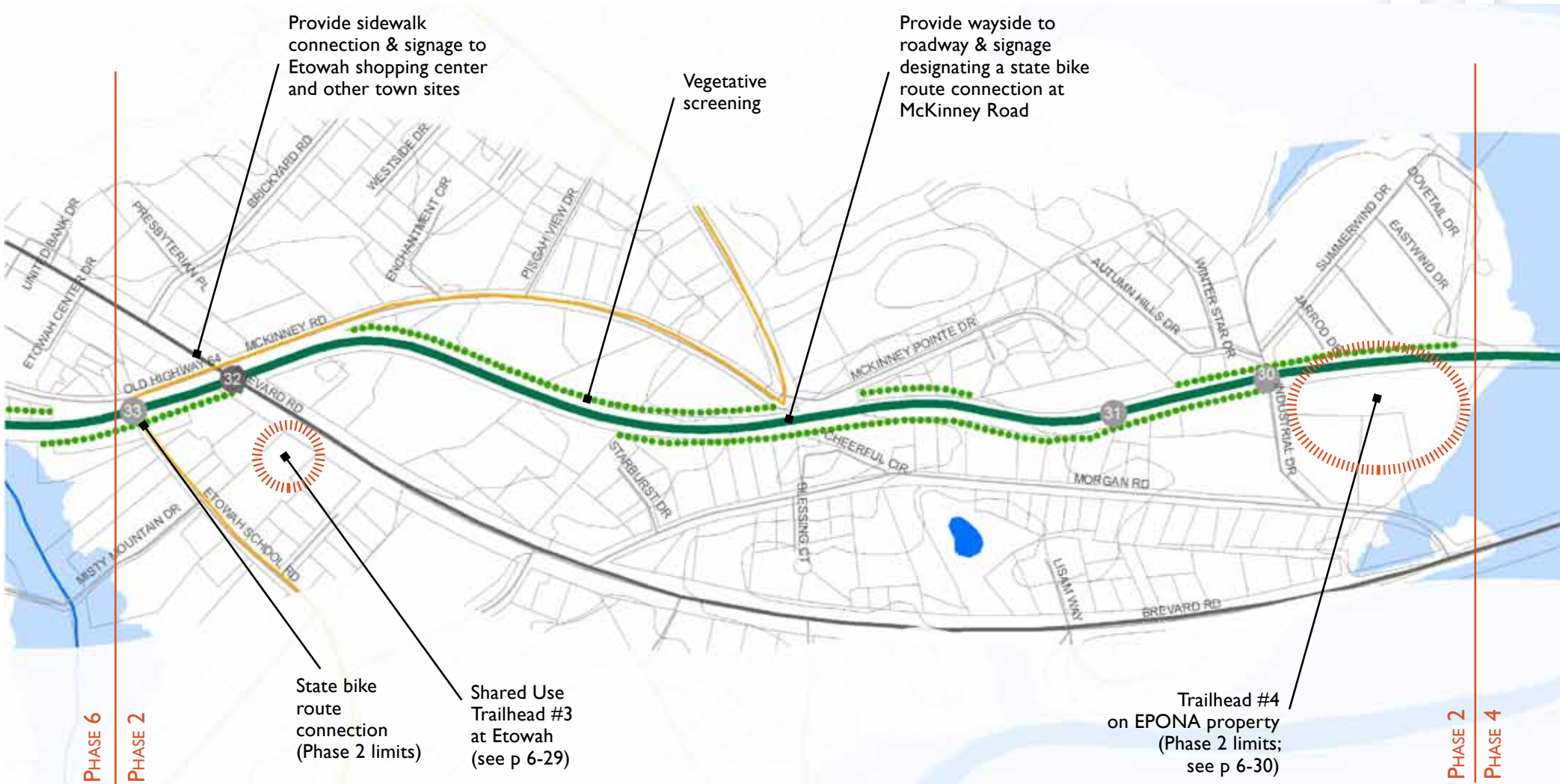

Corridor Overview Key Map

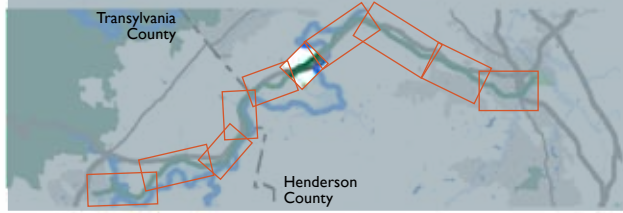

- Type 1 Crossing
- Proposed Rail Trail
- Sidewalk
- Type 2 Crossing
- Vegetative Screening
- Street
- Type 3 Crossing
- Fencing
- Highway
- Existing Greenway
- Contour
- Existing Railroad Bridge
- State Bike Route
- 100-Year Floodplain
- Water
- Conservation Land  
Federal
- State
- Local
- Public Property
- Parcel



# PHASE 3

Laurel Park to Sky Lake Drive

### Description

Phase 3 begins at the shared-use trailhead at First Congregational Church in Laurel Park and extends approximately two miles to just east of Sky Lake Drive. A willing property owner at this location makes it a good point for the limits of Phase 3, where a temporary turnaround could be located or a trail wayside designed until future phases are developed.

### Trestles and Bridges

There is one railroad bridge that would require additional detailed structural analysis before proceeding with the conversion to pedestrian use. Decking and railing will need to be designed on this structure to enhance safety. For more detail as a result of the engineers’ visual inspection of each bridge, please see the Existing Conditions section of this study.

### Social Issues

A combination of fencing and vegetative screening is recommended to enhance property owners’ privacy along Phase 3. A trail connection is recommended for users in the Shaws Creek Farm Road neighborhood. Wayfinding signage is also recommended to help orient trail users.

### Summary

#### Segment Length

2.09 miles

#### Total Budget Costs

Trail Construction - \$805,398

Trail Design and Engineering Fees - \$80,540

Trailhead Construction - \$120,000

Trailhead Design and Engineering Fees - \$12,000

Table 6.4 - Summary of Deed Descriptions

DEED DESCRIPTION	NO. OF PARCELS	PERCENTAGE OF PARCELS
Description includes entire railroad	10	11%
Described to center of railroad	33	35%
Description includes part of right-of-way	3	3%
Description does not include railroad	48	51%
Total	94	

### Trailheads

#### Dixie Diner – Brevard Road

A shared-use trailhead is recommended at Dixie Diner off Brevard Road, where the parking could be expanded and enhanced in the front and rear of the building. Working closely with the owner, signage could be provided as well as an additional nine parking spaces. Closer to the rail trail, an open air pavilion could be installed. If desired, the diner could expand to have outdoor seating that would attract trail users.

Figure 6.5 – Henderson County Phase 3: Laurel Park to Sky Lake Drive

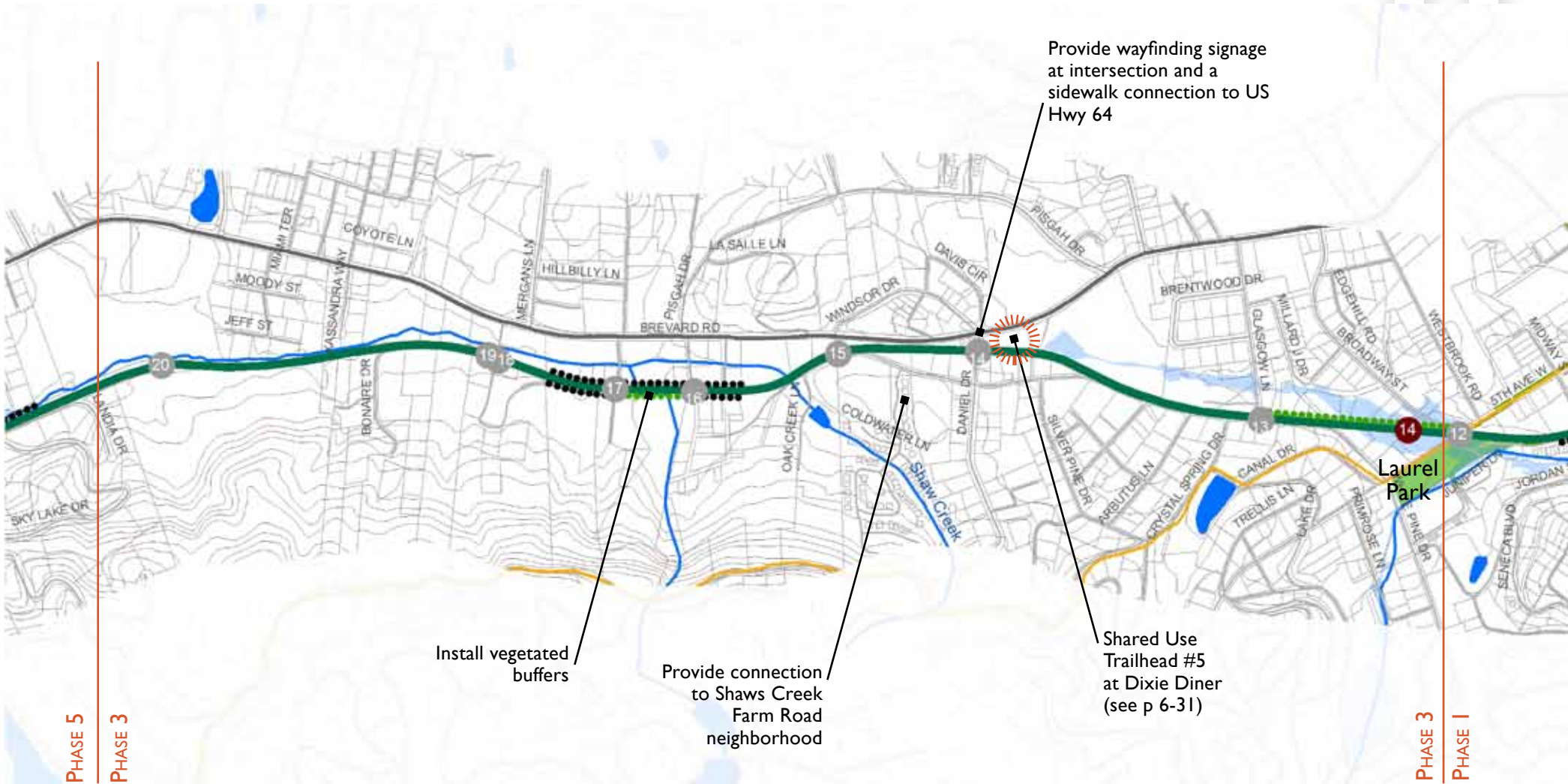

Corridor Overview Key Map

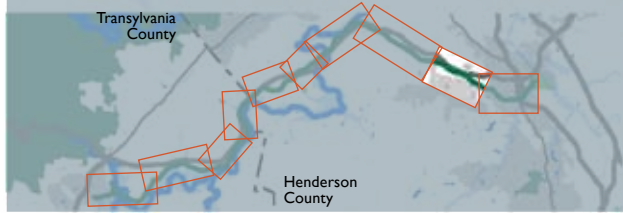

- |                            |                          |                       |                     |
|----------------------------|--------------------------|-----------------------|---------------------|
| ● Type 1 Crossing          | — Proposed Rail Trail    | — Sidewalk            | ■ Conservation Land |
| ● Type 2 Crossing          | ●●● Vegetative Screening | — Highway             | ■ Federal           |
| ● Type 3 Crossing          | ●●● Fencing              | — Street              | ■ State             |
| ● Existing Railroad Bridge | — Existing Greenway      | — Contour             | ■ Local             |
|                            | — State Bike Route       | ■ 100-Year Floodplain | ■ Public Property   |
|                            |                          | ■ Water               | ■ Parcel            |

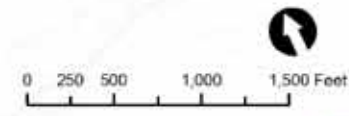



**HENDERSON COUNTY**

**PHASE 4**

*EPONA property to Proposed Shared-Use Trailhead at Grass Roots Café*

**Description**

Phase 4 begins at the proposed equestrian center in Etowah and extends east 2.25 miles to a shared-use trailhead opportunity at the Grass Roots Café along Brevard Rd. The longest trestle is located in Phase 4, and has the potential to be a unique feature area of the Ecusta Rail Trail with interpretive signage. Additionally, there is a scenic overlook opportunity proposed along the French Broad River, which will require further discussion with adjacent property owners.

**Trestles and Bridges**

There are two railroad bridges that will require renovations to increase pedestrian safety. The longest trestle along the corridor, at 725-feet, warrants further structural analysis to determine feasibility for pedestrian use. This trestle will provide overlooks to the French Broad River and a unique trail user experience. For more detail as a result of the engineers’ visual inspection of each bridge, please see the Existing Conditions section of this study.

**Social Issues**

While this section of the trail corridor is more rural than others, it is very scenic and limited screening is recommended due to the bridge crossings and scenic views. There are a few sections where the corridor parallels the roadway and screening is recommended. Additionally, there is a residential development that may benefit from vegetative screening for privacy.

**Trailheads/Overlooks**

**Grass Roots Café – Brevard Road**

Despite the rural location, there is a small pocket of development off Brevard Road that includes a nursery and café. A shared-use trailhead could provide enhancements to the Grass Roots Café

business. This opportunity would attract trail users and provide improved parking for both café patrons and trail users. Trail-side landscape enhancements would beautify the approach to the Brevard Road intersection, where a High Intensity Activated Crosswalk (HAWK) signal is proposed. A spur would connect users to the parking area. Working with café owners, a kiosk and bicycle parking area could be provided near the building, or outdoor dining could be provided with views to the trail.

**French Broad River Overlook at Banner Farm Road**

There are several areas along the Ecusta Rail Trail where the rail corridor very closely parallels the French Broad River. If the adjacent property owners were willing to donate or sell an easement, these locations could become small overlook areas where interpretive signage and gathering space is provided for observation of the river. Approximately half a mile west of the Grass Roots Café shared-use trailhead (refer to Scenic Overlook #1 on map), there is ample space between the rail corridor and the river, where an elevated boardwalk could connect to a viewing platform. An informational kiosk and bicycle parking could be provided. The existing fencing would remain.

**Summary**

**Segment Length**

2.25 miles

**Total Budget Costs**

Trail Construction - \$2,133,046

Trail Design and Engineering Fees - \$213,305

Trailhead Construction - \$171,000

Trailhead Design and Engineering Fees - \$17,100

*Table 6.5 - Summary of Deed Descriptions*

DEED DESCRIPTION	NO. OF PARCELS	PERCENTAGE OF PARCELS
Description includes entire railroad	5	15%
Described to center of railroad	14	41%
Description includes part of right-of-way	-	-
Description does not include railroad	15	44%
Total	34	

Figure 6.6 – Henderson County Phase 4: EPONA property to Proposed Shared-Use Trailhead at Grass Roots Café

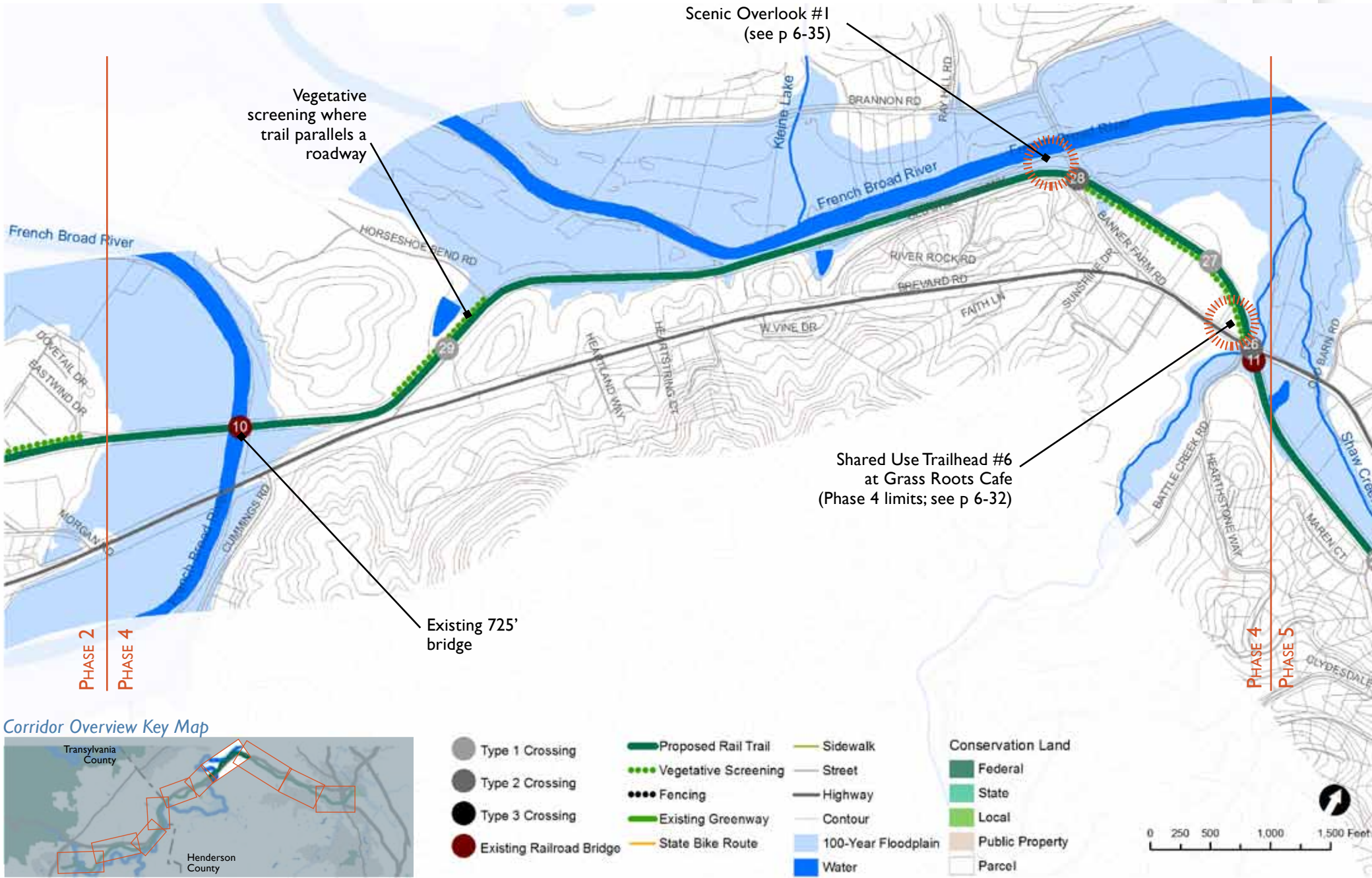

## HENDERSON COUNTY

# PHASE 5

Shared-use Trailhead at Grass Roots Café to Sky Lake Drive

### **Description**

Phase 5 would close a major gap between the town and city centers of Laurel Park and Hendersonville and it would provide a reach to the limits of Henderson County. At almost 2.5 miles in length, Phase 5 extends from the western limits of Phase 3 to the shops south of Brevard Road, in Horse Shoe.

### **Trestles and Bridges**

There are two railroad bridges that will require renovations to increase pedestrian safety. Decking and railing is recommended at a minimum. For more detail as a result of the engineers' visual inspection of each bridge, please see the Existing Conditions section of this study.

### **Social Issues**

Vegetative screening is recommended along Shaw Creek, where there are private residences. The trail, creek, and adjacent housing need separation. At Horse Shoe Center, a trail spur should be provided to connect users to restaurants, commercial areas, and the farmers market. This connection could be made at the intersection improvements at Brevard Road or just south of this intersection. Neighborhoods south of the trail benefit from the hills that create a natural buffer between homes and the trail.

### **Trailheads/Overlooks**

#### **Shaw Creek Interpretive Area**

A potential educational/interpretive area could be provided along Shaw Creek, just north of Hunters Glen Road. This could also become a simple seating area or rest stop.

### **Summary**

#### **Segment Length**

2.4 miles

#### **Total Budget Costs**

Trail Construction - \$853,148

Trail Design and Engineering Fees - \$85,315

Table 6.6 - Summary of Deed Descriptions

DEED DESCRIPTION	NO. OF PARCELS	PERCENTAGE OF PARCELS
Description includes entire railroad	4	5%
Described to center of railroad	34	46%
Description includes part of right-of-way	1	1%
Description does not include railroad	35	47%
Total	74	



Figure 6.7 – Henderson County Phase 5: Shared-use Trailhead at Grass Roots Café to Sky Lake Drive

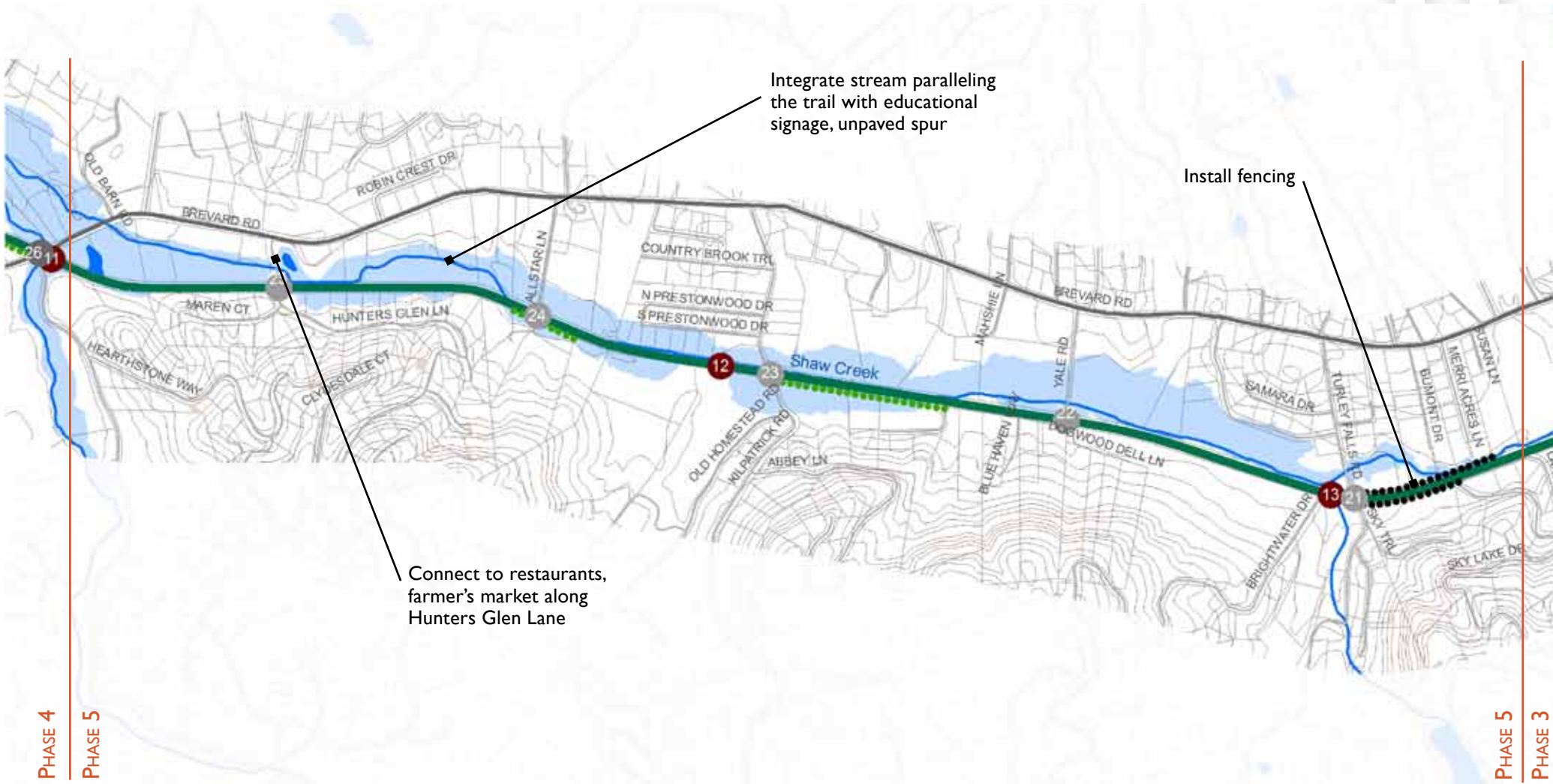

Corridor Overview Key Map

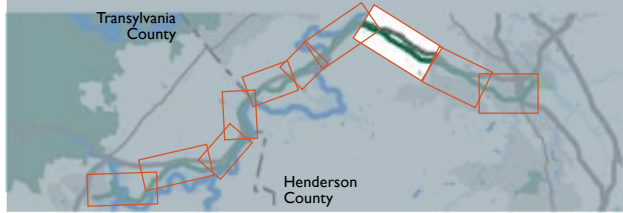

- |                            |                          |                       |                     |
|----------------------------|--------------------------|-----------------------|---------------------|
| ● Type 1 Crossing          | — Proposed Rail Trail    | — Sidewalk            | ■ Conservation Land |
| ● Type 2 Crossing          | ●●● Vegetative Screening | — Street              | ■ Federal           |
| ● Type 3 Crossing          | ●●● Fencing              | — Highway             | ■ State             |
| ● Existing Railroad Bridge | — Existing Greenway      | — Contour             | ■ Local             |
|                            | — State Bike Route       | ■ 100-Year Floodplain | ■ Public Property   |
|                            |                          | ■ Water               | □ Parcel            |

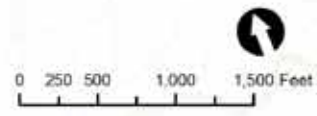

# PHASE 6

Henderson/Transylvania County limits to Etowah

### Description

Phase 6 is the last phase in Henderson County, extending from Etowah to the Henderson/Transylvania county line. Further discussion is recommended between the two counties to determine the most logical trail connections and development responsibilities where the boundaries meet. Phase 6 is 1.8 miles long with significant recommended intersection improvements.

### Trestles and Bridges

There are three railroad bridges of various lengths that will require renovations to increase pedestrian safety. Decking and railing is recommended at a minimum for pedestrian use. For more detail as a result of the engineers' visual inspection of each bridge, please see the Existing Conditions section of this study.

### Social Issues

A combination of vegetative screening and fencing is recommended along several areas of this phase, as seen on the map. There are single-family homes located on the pocket between the trail corridor and Brevard Road. Homeowners in these neighborhoods should be contacted to determine if a connection to the trail is desired.

### Trailheads/Overlooks

There are no trailheads or overlooks recommended in Phase 6.

### Summary

#### Segment Length

1.8 miles

#### Total Budget Costs

Trail Construction - \$1,025,364

Trail Design and Engineering Fees - \$102,536

Table 6.7 - Summary of Deed Descriptions

DEED DESCRIPTION	NO. OF PARCELS	PERCENTAGE OF PARCELS
Description includes entire railroad	4	5%
Described to center of railroad	34	46%
Description includes part of right-of-way	1	1%
Description does not include railroad	35	47%
Total	74	

Figure 6.8 – Henderson County Phase 6: Henderson/Transylvania County limits to Etowah



Corridor Overview Key Map

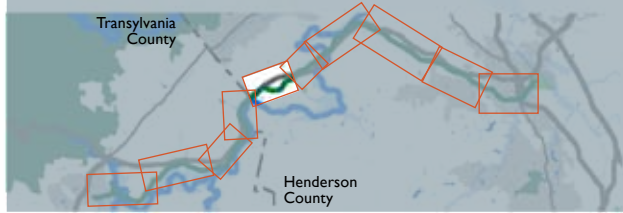

- |                            |                          |                       |                   |
|----------------------------|--------------------------|-----------------------|-------------------|
| ● Type 1 Crossing          | — Proposed Rail Trail    | — Sidewalk            | Conservation Land |
| ● Type 2 Crossing          | ●●● Vegetative Screening | — Street              | ■ Federal         |
| ● Type 3 Crossing          | ●●● Fencing              | — Highway             | ■ State           |
| ● Existing Railroad Bridge | — Existing Greenway      | — Contour             | ■ Local           |
|                            | — State Bike Route       | ■ 100-Year Floodplain | ■ Public Property |
|                            |                          | ■ Water               | □ Parcel          |





# PHASE I

Brevard Bike Path to Proposed Everett Road Trailhead

### Description

Phase I begins in the City of Brevard, where it will connect with the Brevard Bike Path just south of Transylvania Regional Hospital at the west end of the rail line. Phase I extends 2.4 miles east to the proposed trailhead near Everett Road. A trail spur is also recommended at the Transylvania Activity Center, where Ecusta Road intersects with the rail line. The spur would extend north and connect to the old Ecusta Mill site and then west, creating a loop that connects back to the Brevard Bike Path.

### Trestles and Bridges

Two railroad bridges will require pedestrian renovations to increase safety. The first bridge, across Davidson River, is also a roadway overpass. Decking and railing is recommended at a minimum for pedestrian use. For more detail as a result of the engineers' visual inspection of the bridges, please see the Existing Conditions section of this study.

### Social Issues

In addition to providing extended mileage along the City's existing bicycle trail, Phase I connects with state bicycle routes at Davidson River Road, Old US Highway 64, and Everett Road. Most of the land use along Phase I is mixed, with some single-family homesteads, agricultural use, and utility/industrial. Fencing is recommended along several industrial operation areas and agricultural fields. The substation at Everett Road could also benefit from some vegetative screening, as well as where the rail corridor begins to parallel Old Hendersonville Highway.

### Trailheads/Overlooks Everett Road Trailhead

Just beyond the stand of trees along Old Hendersonville Highway, before the intersection

of Everett Road, the roadway begins to parallel the rail line. Due to the convergence of the two transportation corridors, this finger of land serves mostly as a buffer between the roadway and adjacent property. There is a flat pad of approximately 10,000 square feet where a small trailhead could be developed with the cooperation of a willing landowner. Thirty-five parking spaces, a small pavilion or restroom building, a playground area, and landscape enhancements would provide the facilities necessary for the proposed rail trail. Working closely with the property owner, the driveway could be paved or enhanced, and evergreen screening provided for privacy.

### Summary

#### Segment Length

2.4 miles

#### Total Budget Costs

Trail Construction - \$1,077,724

Trail Design and Engineering Fees - \$107,772

Trailhead Construction - \$140,000

Trailhead Design and Engineering Fees - \$14,000

Table 6.8 - Summary of Deed Descriptions

DEED DESCRIPTION	NO. OF PARCELS	PERCENTAGE OF PARCELS
Description includes entire railroad	2	4%
Described to center of railroad	12	24%
Description includes part of right of way	7	14%
Description does not include railroad	19	38%
No description of railroad	10	20%
Total	50	

Figure 6.9 – Transylvania County Phase I: Brevard Bike Path to Proposed Everett Road Trailhead

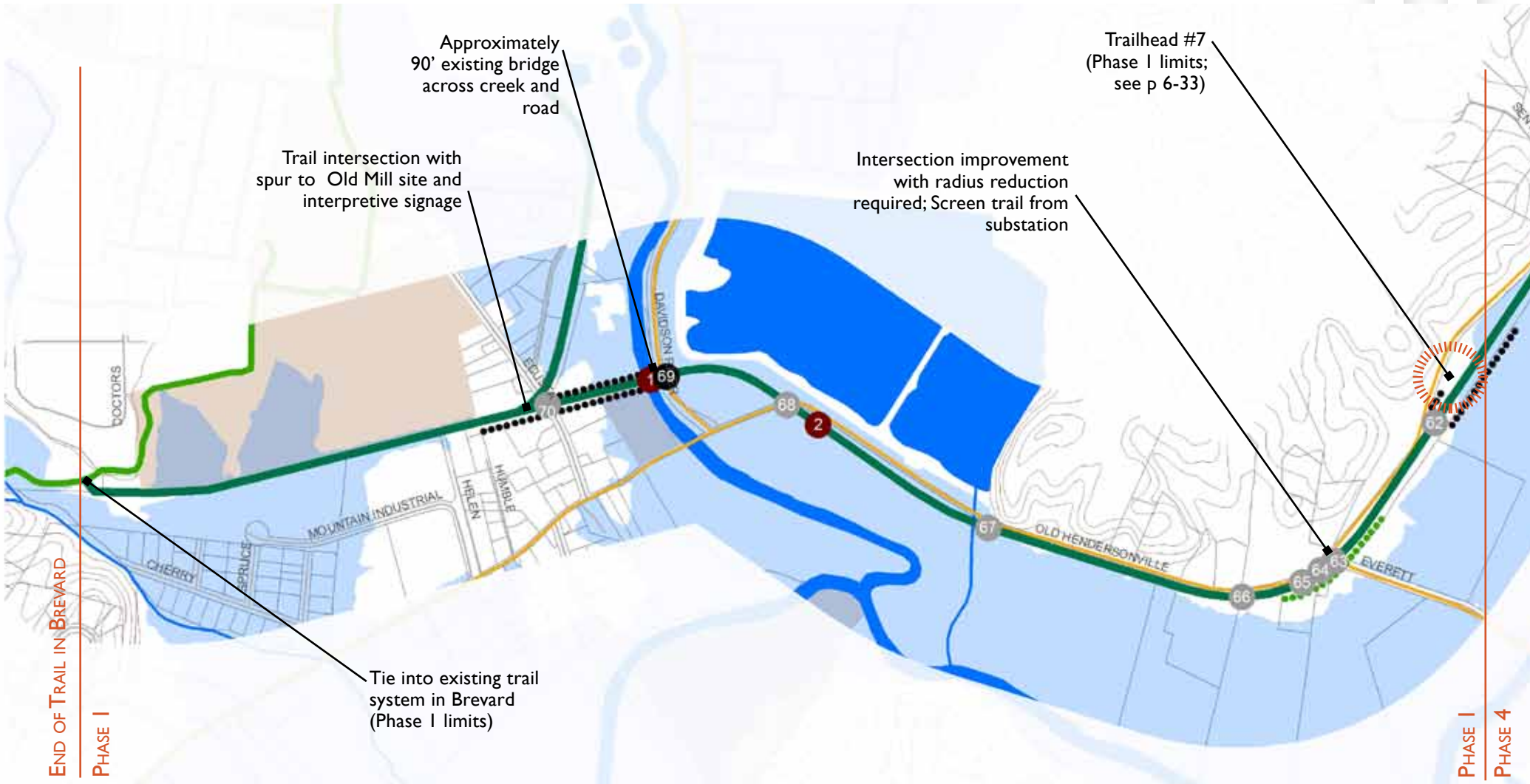

Corridor Overview Key Map

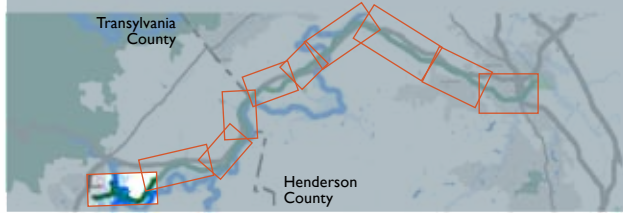

- |                            |                          |                       |                   |
|----------------------------|--------------------------|-----------------------|-------------------|
| ● Type 1 Crossing          | — Proposed Rail Trail    | — Sidewalk            | Conservation Land |
| ● Type 2 Crossing          | ●●● Vegetative Screening | — Street              | ■ Federal         |
| ● Type 3 Crossing          | ●●● Fencing              | — Highway             | ■ State           |
| ● Existing Railroad Bridge | — Existing Greenway      | — Contour             | ■ Local           |
|                            | — State Bike Route       | ■ 100-Year Floodplain | ■ Public Property |
|                            |                          | ■ Water               | □ Parcel          |

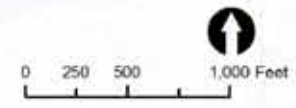

# PHASE 2

Proposed Crab Creek Trailhead to Proposed French Broad River Overlook

### Description

Much of the Transylvania County Ecusta Rail Trail corridor is agricultural, with scenic views of pastures and farmland. Single-family homes and commercial areas will be connected to the trail closer to the Henderson County boundary. Phase 2 will connect to functional areas once the trailhead and overlook area are constructed. From the proposed Crab Creek Road trailhead, Phase 2 extends 1.4 miles to the French Broad River overlook. There are connections to the state bicycle route at Crab Creek Road.

### Trestles and Bridges

There is one railroad bridge west of Crab Creek Road that will require renovations to increase pedestrian safety. Decking and railing is recommended at a minimum for pedestrian use. For more detail as a result of the engineers' visual inspection of each bridge, please see the Existing Conditions section of this study.

### Social Issues

Extensive fencing is recommended in Phase 2. Several single-family homes are located in very close proximity to the corridor, and with little to no grade separation, fencing will provide the most adequate screening. There are also some agricultural operations that require fencing to protect privacy and discourage access.

### Trailheads/Overlooks

#### Crab Creek Road Trailhead

South of the rail line and east of Crab Creek Road, a small wooded lot exists that could accommodate a modest trailhead with approximately 20 parking spaces and several shade structures located among the trees. Some selective clearing would be required to provide for parking, but the wooded character of the lot could be preserved otherwise.

Further discussion with the existing property owner and the acquisition of this property will be required.

### Meeting with the French Broad River Overlook

South of the proposed Ecusta Rail Trail is a section of the corridor that is at a similar grade with the French Broad River. If the landowner was willing to negotiate this section of their property, a viewing platform with a boardwalk and an open-air pavilion would provide trail users a unique view of the French Broad River. Adequate space would be provided for an outdoor classroom and small groups to gather. Selective clearing would maximize views yet maintain the wooded character of the lot. Interpretive signage or plant identification could also be part of the overlook.

### Summary

#### Segment Length

1.4 miles

#### Total Budget Costs

Trail Construction - \$484,460

Trail Design and Engineering Fees - \$48,446

Trailhead Construction - \$355,000

Trailhead Design and Engineering Fees - \$35,500

Table 6.9 - Summary of Deed Descriptions

DEED DESCRIPTION	NO. OF PARCELS	PERCENTAGE OF PARCELS
Description includes entire railroad	-	-
Described to center of railroad	22	59%
Description includes part of right-of-way	6	16%
Description does not include railroad	6	16%
No description of railroad	3	8%
Total	37	



Figure 6.10 – Transylvania County Phase 2: Proposed Crab Creek Trailhead to Proposed French Broad River Overlook

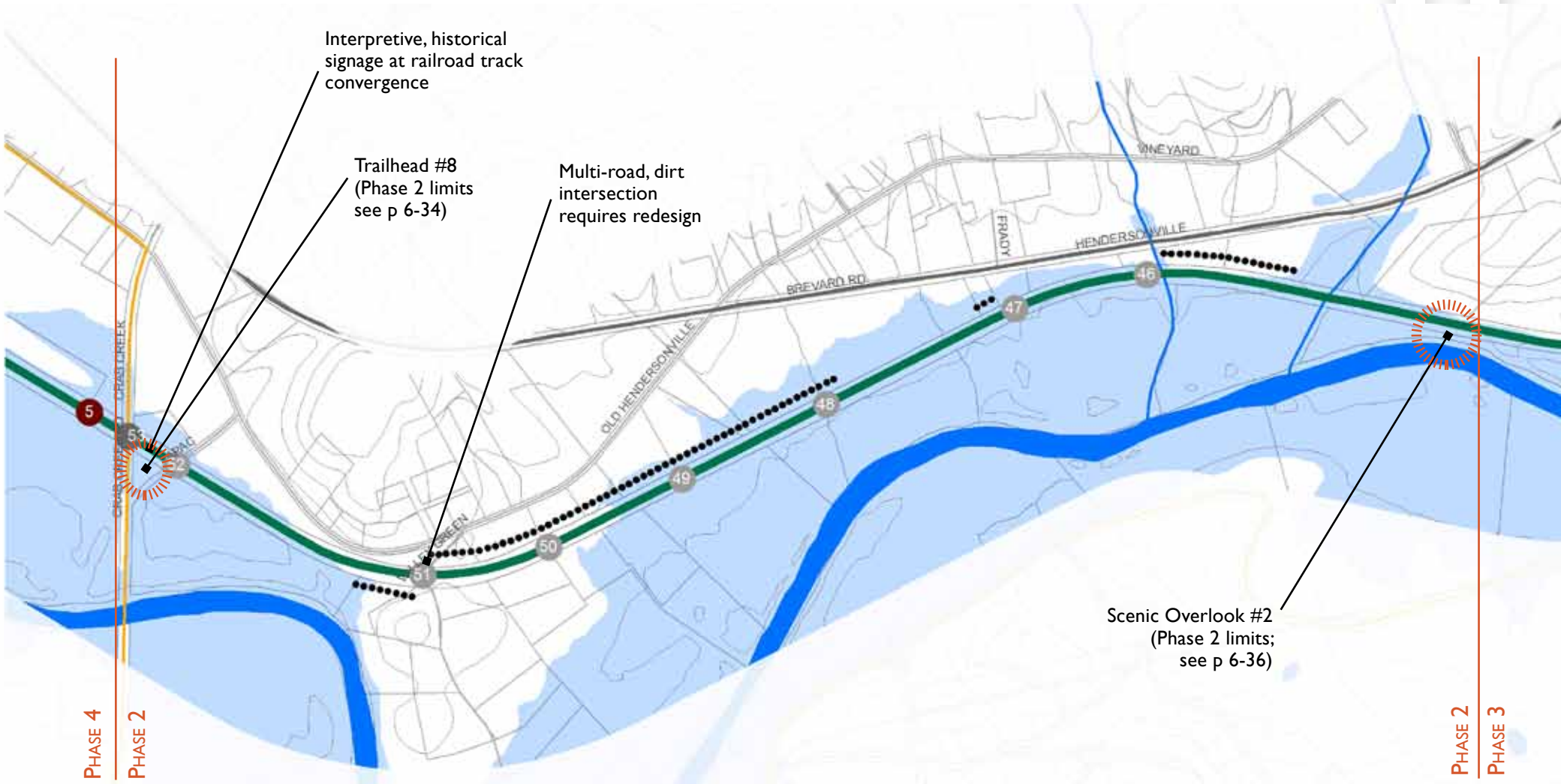

Corridor Overview Key Map

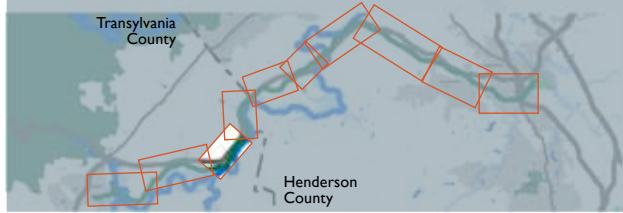

- |                            |                          |                       |                   |
|----------------------------|--------------------------|-----------------------|-------------------|
| ● Type 1 Crossing          | — Proposed Rail Trail    | — Sidewalk            | Conservation Land |
| ● Type 2 Crossing          | ●●● Vegetative Screening | — Street              | ■ Federal         |
| ● Type 3 Crossing          | ●●● Fencing              | — Highway             | ■ State           |
| ● Existing Railroad Bridge | — Existing Greenway      | — Contour             | ■ Local           |
|                            | — State Bike Route       | ■ 100-Year Floodplain | ■ Public Property |
|                            |                          | ■ Water               | □ Parcel          |

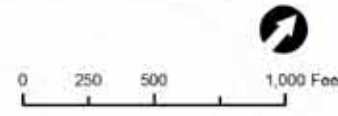

**TRANSYLVANIA COUNTY**

**PHASE 3**

*French Broad River Overlook to Transylvania County/  
Henderson County Limits*

**Description**

Phase 3 connects an important reach to the Henderson County boundary. With Phases 1 and 2 complete, this will mark the completion of a vast majority of the mid section of the Ecusta Rail Trail. Phase 3 extends 1.7 miles from the French Broad River overlook to the county boundary. Further discussion is recommended between the two counties to determine the most logical trail connections and development responsibilities where the boundaries meet. Connections can be made with the state bicycle route at Grove Bridge Road.

**Trestles and Bridges**

There is one railroad bridge, approximately 90' in length, which will require renovations to increase pedestrian safety. Decking and railing is recommended at a minimum for pedestrian use. For more detail as a result of the engineers' visual inspection of each bridge, please see the Existing Conditions section of this study.

**Social Issues**

Some vegetative screening is recommended along the south side of the trail corridor, primarily to enhance agricultural operation privacy. In Phase 3, additional connections can be made with the Transylvania County River Access Park near Grove Bridge Road. Depending on development plans for this park, a parking area or trailhead facility could be provided, with a trail spur to the Ecusta Rail Trail along Grove Bridge Road.

**Trailheads/Overlooks**

There are no trailheads or overlooks recommended in Phase 3.

**Summary**

**Segment Length**

1.7 miles

**Total Budget Costs**

Trail Construction - \$743,878

Trail Design and Engineering Fees - \$74,388

*Table 6.10 - Summary of Deed Descriptions*

DEED DESCRIPTION	NO. OF PARCELS	PERCENTAGE OF PARCELS
Description includes entire railroad	8	31%
Described to center of railroad	5	19%
Description includes part of right-of-way	2	8%
Description does not include railroad	4	15%
No description of railroad	7	27%
Total	26	

Figure 6.11 – Transylvania County Phase 3 French Broad River Overlook to Transylvania County/Henderson County Limits

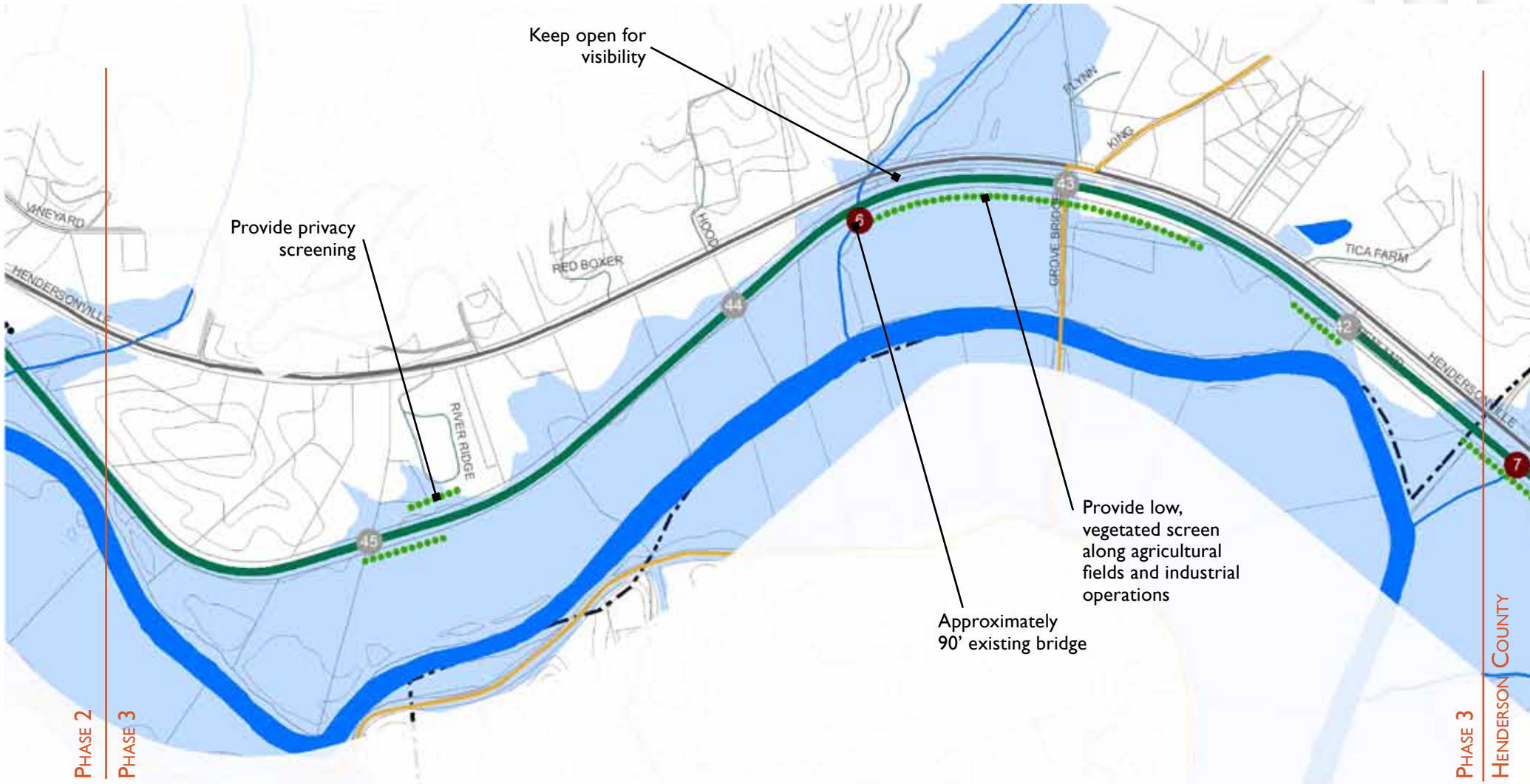

Corridor Overview Key Map

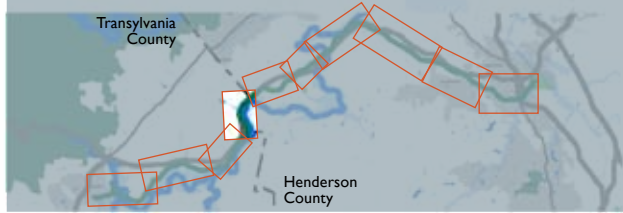

- |                            |                          |                       |                   |
|----------------------------|--------------------------|-----------------------|-------------------|
| ● Type 1 Crossing          | — Proposed Rail Trail    | — Sidewalk            | Conservation Land |
| ● Type 2 Crossing          | ••• Vegetative Screening | — Highway             | ■ Federal         |
| ● Type 3 Crossing          | ••• Fencing              | — Street              | ■ State           |
| ● Existing Railroad Bridge | — Existing Greenway      | — Contour             | ■ Local           |
|                            | — State Bike Route       | ■ 100-Year Floodplain | □ Parcel          |
|                            |                          | ■ Water               | ■ Public Property |





# PHASE 4

Everett Road Trailhead to Crab Creek Trailhead

### Description

Phase 4 is the lengthiest section of the Ecusta Rail Trail corridor. At 2.8 miles, it is also the most remote, with agriculture the primary adjacent use. Therefore, it is recommended as the final reach of the project, closing the last remaining gap in the trail corridor. Two functional connections will be made from the proposed Everett Road trailhead (Phase 1) to the proposed Crab Creek trailhead (Phase 2).

### Trestles and Bridges

There are two railroad bridges of various lengths that will require renovations to increase pedestrian safety. Decking and railing is recommended at a minimum for pedestrian use. For more detail as a result of the engineers' visual inspection of each bridge, please see the Existing Conditions section of this study.

### Social Issues

To limit access and protect privacy of agricultural operations along the corridor, fencing and vegetative screening is recommended on the north and south sides of sections of Phase 4. Wayfinding signage, mileage markers, and emergency call phones will be important in this section for safety and security because it is a more remote stretch of the trail.

### Trailheads/Overlooks

There are no trailheads or overlooks recommended in Phase 6.

### Summary

#### Segment Length

2.8 miles

#### Total Budget Costs

Trail Construction - \$1,082,502

Trail Design and Engineering Fees - \$108,250

Table 6.11 - Summary of Deed Descriptions

DEED DESCRIPTION	NO. OF PARCELS	PERCENTAGE OF PARCELS
Description includes entire railroad	8	31%
Described to center of railroad	5	19%
Description includes part of right-of-way	2	8%
Description does not include railroad	4	15%
No description of railroad	7	27%
Total	26	

Figure 6.12 – Transylvania County Phase 4: Everett Road Trailhead to Crab Creek Trailhead

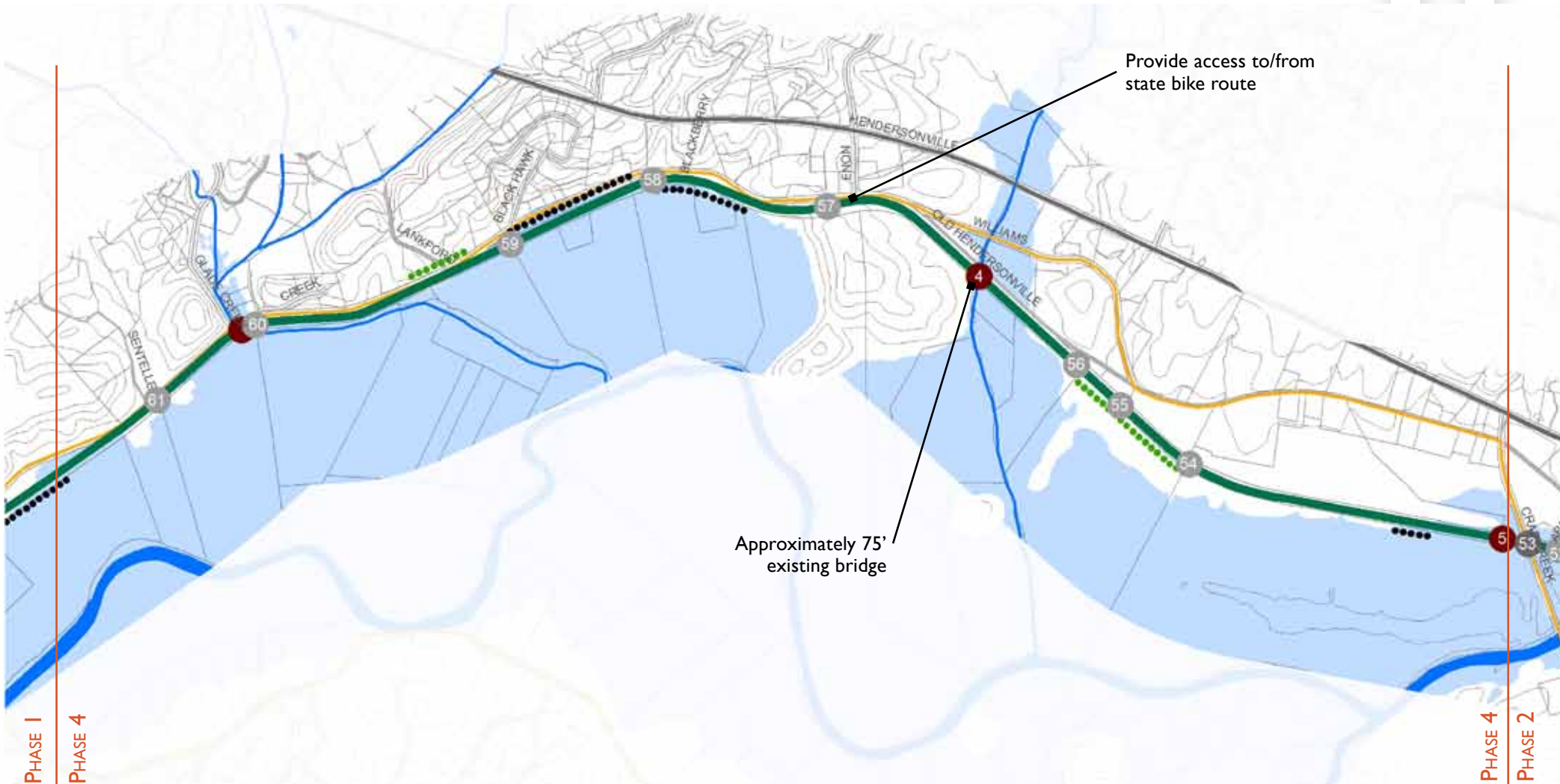

Corridor Overview Key Map

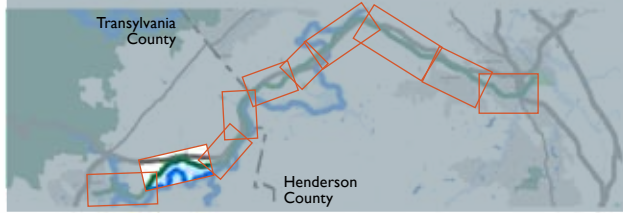

- |                            |                          |                       |                   |
|----------------------------|--------------------------|-----------------------|-------------------|
| ● Type 1 Crossing          | — Proposed Rail Trail    | — Sidewalk            | Conservation Land |
| ● Type 2 Crossing          | ●●● Vegetative Screening | — Highway             | ■ Federal         |
| ● Type 3 Crossing          | ●●● Fencing              | — Street              | ■ State           |
| ● Existing Railroad Bridge | — Existing Greenway      | — Contour             | ■ Local           |
|                            | — State Bike Route       | ■ 100-Year Floodplain | □ Parcel          |
|                            |                          | ■ Water               | ■ Public Property |

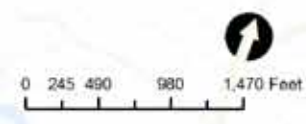

Table 6.12 – Summary of Estimated Costs and Benefits

COSTS	
Design and Engineering	\$1,343,872
Trail	\$989,872
Trailheads	\$354,000
Construction	
Earthwork, Demolition, Clearing, & Erosion Control	\$2,407,546
General Construction	\$3,116,250
Bridges	\$2,089,800
Additional Construction	\$635,335
Trailhead Construction	\$2,950,000
Cost Factor	\$2,239,786
TOTAL TRAIL COSTS (ONE-TIME)	\$9,898,717
TOTAL TRAILHEAD COSTS (ONE-TIME)	\$3,540,000
ESTIMATED ACQUISITION COST (ONE-TIME)	\$1,200,000 - \$4,500,000
BENEFITS	
Economic Impact of Upfront Construction (one- time)	\$20,000,000
Property Value Impact	
Property Value Increases (one-time)	\$22,000,000
Additional Tax Revenues (annual)	\$160,000
Economic Impact of Additional Tourism Activity (annual)	\$2,000,000
Direct Use Value Impact (annual)	\$2,200,000
Health Care Cost Reduction Impact (annual)	\$5,000,000
Environmental Impact (annual)	Minimal
TOTAL BENEFITS (ONE-TIME)	\$42,000,000
TOTAL BENEFITS (ANNUAL)	\$9,360,000

## Summary of Estimated Costs and Benefits

The following table provides conservative estimates of the cost of acquisition, design, and construction of the proposed Ecusta Rail Trail. Costs may vary depending on the trail characteristics chosen, the number of trailheads implemented and the acquisition cost negotiated. In addition, Trailhead costs do not include real estate estimates. Benefits are provided based on the Economic Impact Analysis performed for comparison to costs.

Greater detail on cost estimates is provided in Appendix E.

## Trailhead and Support Facilities

Several segments of the recommended alignment run outside of the existing rail right-of-way to take advantage of previously established trails or to provide parking, restrooms, and other support features for trail users. **Proposed trailhead areas were developed at the conceptual level only to explore potential opportunities for such facilities; they will require further study and design, as well as coordination with landowners, NCDOT, and local development plans and ordinances.**

Trailhead concept designs and descriptions are provided on the following pages.



The Williams Street Trailhead is designed to be a continuation of the Ecusta Rail Trail as a linear park. With fifty-four parking spaces and three open-air pavilions, this destination park will be heavily used by picnickers and passers-by alike. An outdoor learning center is centrally located within the park and a vehicular drop-off provides easy load/unloading access, student drop-off, etc.

Located along the East/West axis of the outdoor learning center is a large event lawn with terraced seating. This amphitheatre style is presented with a backdrop of wetlands and floodplains. Furthermore, all site elements have been buffered from adjacent uses through the preservation of existing or increased density of vegetation.

## TRAILHEAD #1

Figure 6.13– Potential Trailhead at Williams Street



## TRAILHEAD #2

Trailside landscape enhancements lead the Ecusta Rail Trail along Wash Creek and connect to the Laurel Park Trailhead. Shared-use parking provided by First Congregational Church has been restriped to add additional trail parking and improve circulation. Landscape enhancements lead the concrete sidewalk from the improved parking to the Ecusta Rail Trail. Additional landscape buffers,

flowering trees, and canopy trees, have been added to screen adjacent properties and add additional shade to the trailhead.

Figure 6.14 – Potential Shared Use Trailhead at Laurel Park

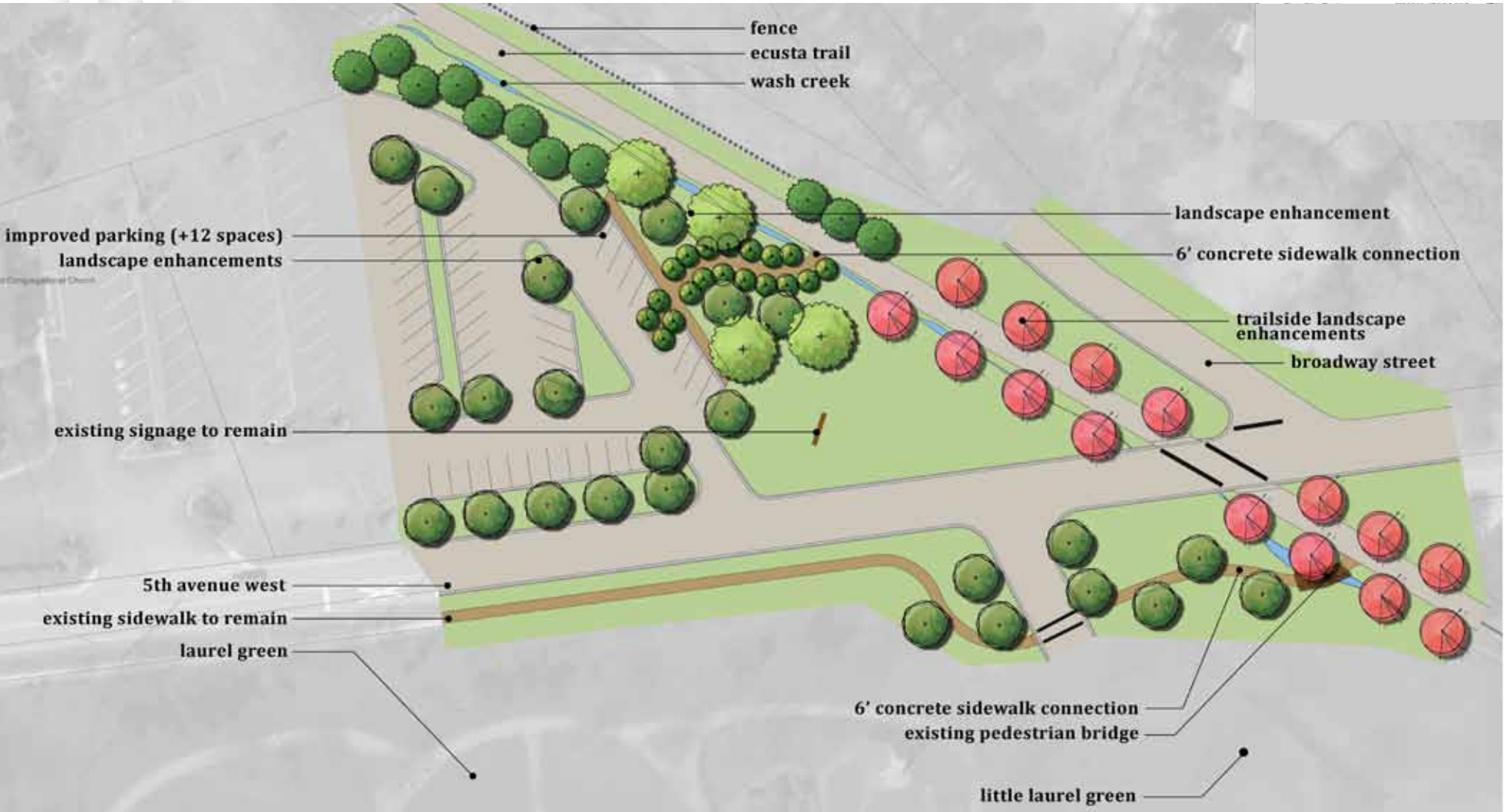



# TRAILHEAD #3

The Etowah Town Center Trailhead is an expansion of an existing parking lot. This parking lot, owned and operated by the Etowah Baptist Church, is improved with landscape and restroom/picnic shelters. The improved circulation allows for an expansion of 15 parking spaces with a 6' concrete sidewalk and 10' asphalt path connecting back to the Ecusta Rail Trail along Etowah School Road.

Additional trailside landscape enhancements are illustrated along the Ecusta Rail Trail to alert trail users of a trailhead in close proximity. A 20'x40' open-air pavilion with restroom can be utilized by both trail users and through programming with Etowah Baptist Church.

Figure 6.15– Potential Shared Use Trailhead at Etowah





## TRAILHEAD #4

The EPONA Property, situated mostly in the floodplain, gives a unique opportunity to trail users as a destination and equine facility. This facility has improved trails with both natural and paved surfaces to accommodate multiple uses. Pastures and stable areas are easily accessible from the centrally located parking lot, truck/trailer parking lot, and equine learning center. Multiple

access points along the Ecusta Rail Trail improve trail circulation patterns and allow for maximized use of the EPONA Property. Open-air pavilions are strategically located throughout the trails to maximize long-views, provide additional privacy, etc.

Figure 6.16 – Potential Trailhead at the EPONA Property



Improved one-way circulation, streetscape landscape enhancements, outdoor plazas, and potential diner expansion are all parts of the Brevard Road and Daniel Drive Trailhead. An additional eight parking spaces have been added to Dixie Diner, as well as a rear entrance to potential restaurant expansion. Two open-air pavilions allow for outdoor dining/picnic opportunities.

Additional landscape improvements are included to enhance trail experience, provide shading, and screen dumpster/utilities from trail users.

## TRAILHEAD #5

Figure 6.17– Potential Shared Use Trailhead at Brevard Road & Daniel Drive

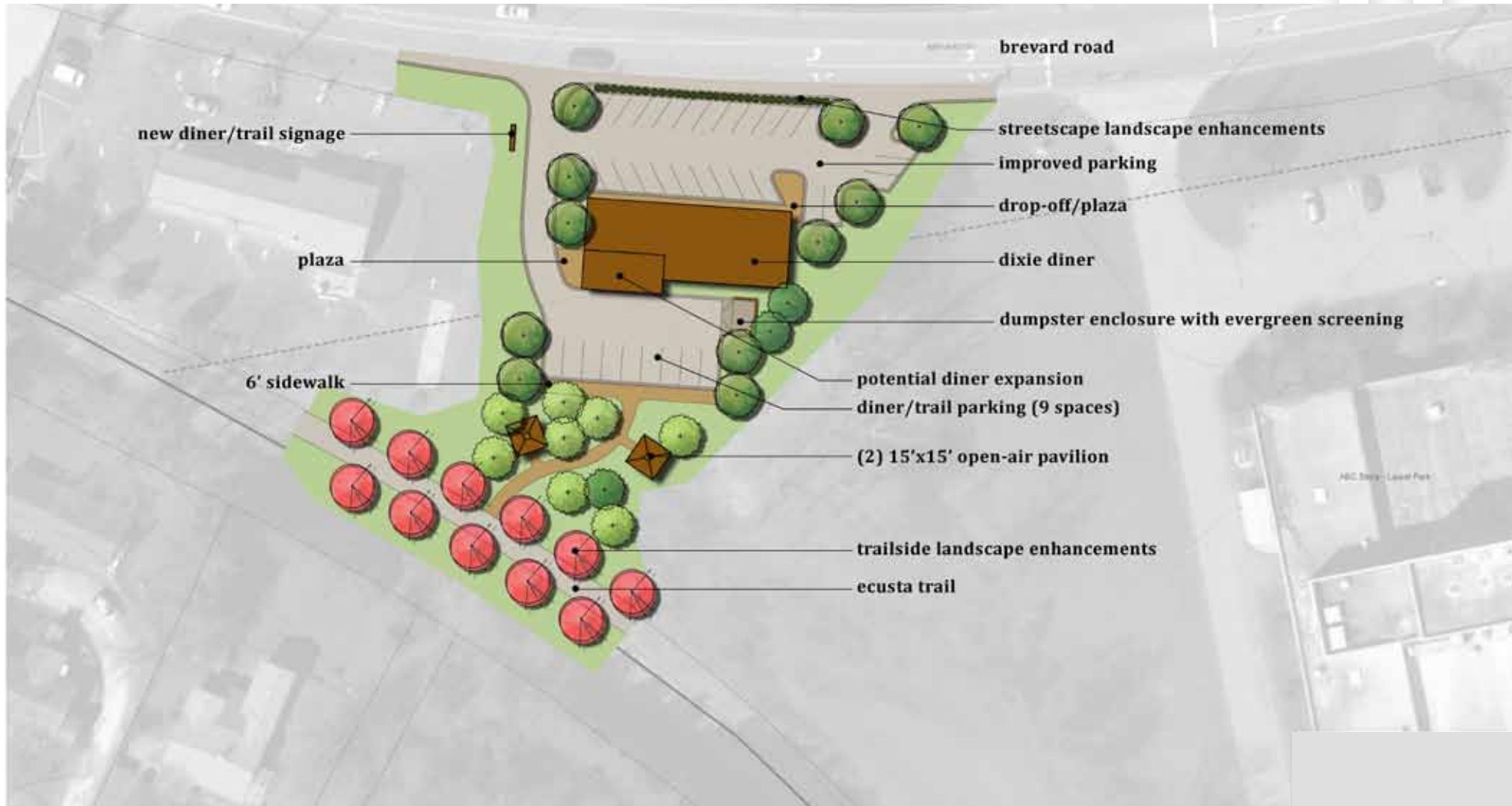



## TRAILHEAD #6

The Grass Roots café along Brevard Road is located at a high traffic area with great opportunities for restaurant expansion, outdoor dining, etc. Improved 90 degree parking allows for an additional 8 parking spaces, defined dumpster enclosure located away from parking, and outdoor

dining opportunities. The center island has been redefined to allow for monument signage, additional landscaping, a kiosk or covered bike parking, and crosswalk connections to both the café and Ecusta Rail Trail.

Figure 6.18 – Potential Shared Use Trailhead at Grass Roots Cafe

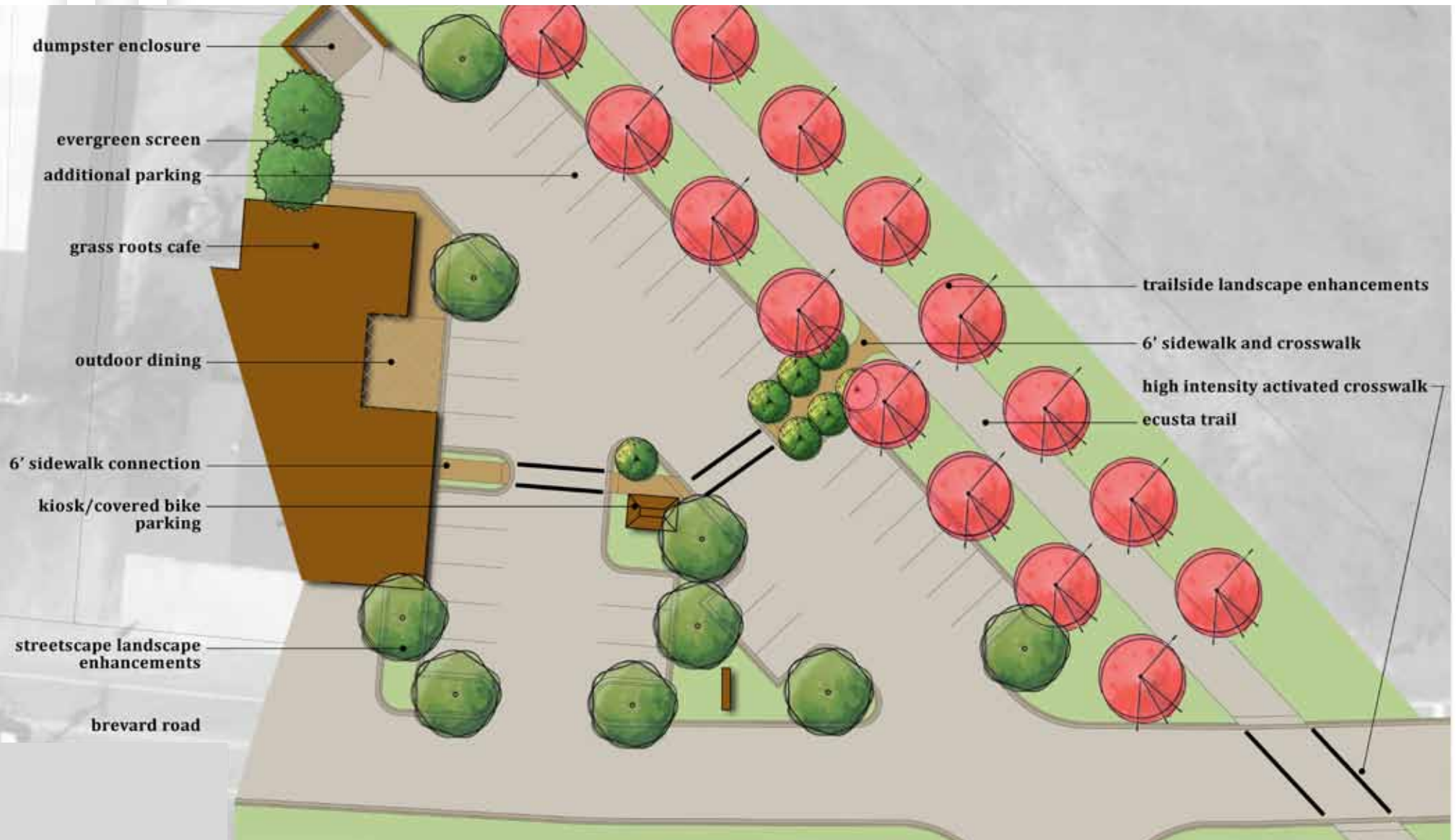



## TRAILHEAD #7

The Old Hendersonville Highway Trailhead includes development of 35 parking spaces, an open-air pavilion and kiosk with future restroom facilities, and additional landscape. The open-air pavilion is centrally located on the site, and all trail access would occur centrally through this facility.

Landscape enhancements buffer the parking lot from the trail and additional evergreen screening buffer adjacent land uses. Additional trailhead signage is proposed both along the trail and along Old Hendersonville Highway.

Figure 6.19– Potential Trailhead at Everett Road & Old Hendersonville Highway



## TRAILHEAD #8

The Crab Creek Road Trailhead has two access points from the Ecusta Trail, one as a trailside pavilion location and the other as a direct connection to parking, additional pavilion facilities, and informational kiosk. Proposed circulation allows for 19 spaces with four open-air pavilions located within site distance of all spaces. A

proposed kiosk and park signage adjacent to the roadway encourages pedestrian traffic along Crab Creek Road and invites users through the center of the park. Existing vegetation is maintained throughout the site, both in landscape islands and buffers between parking and trail access.

Figure 6.20 – Potential Trailhead at Crab Creek Road

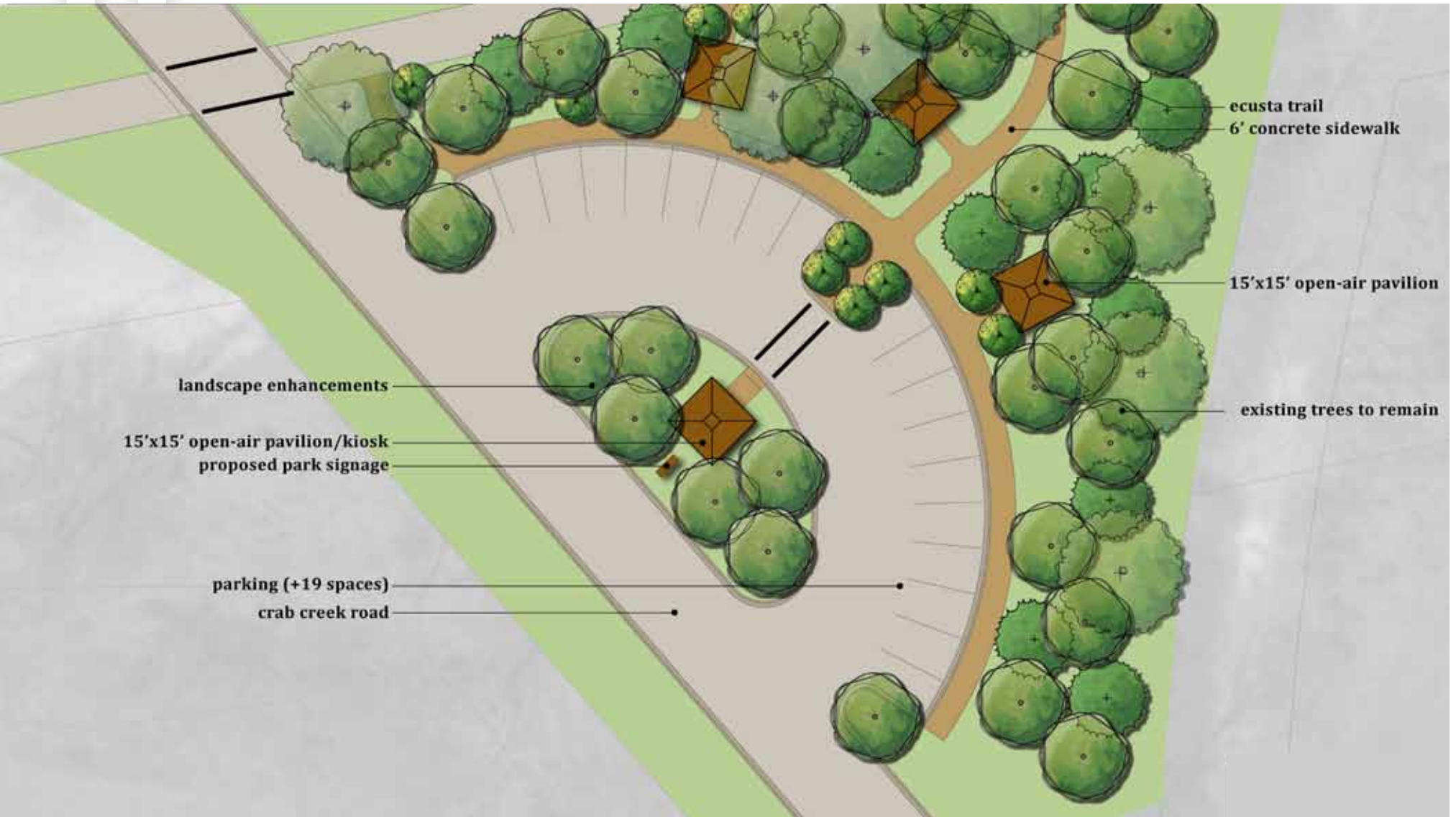



# SCENIC OVERLOOK #1

The Banner Farm Road Overlook provides a unique trail amenity by allowing users the opportunity to view the French Broad River from the tree tops. A two-sided informational kiosk is placed at the entrance to the overlook for informational purposes and should be utilized to educate the user about this specific vantage point, historical facts about the river, and the

environment. Convenient bike racks are placed at the overlook entry. The overlook is a 40'x40' cantilevered viewing platform with built-in seating around the edges (approximately 40 people seated comfortably). With a gentle slope, the overlook will be elevated approximately 15' above the river, giving a unique perspective on the French Broad River.

Figure 6.21 – Potential Scenic Overlook and Interpretive Area at Banner Farm Road





## SCENIC OVERLOOK #2

Similar to the Banner Farm Road Overlook, this overlook of the French Broad River is intended to allow for a unique perspective on the river. An open-air pavilion is centrally located at the overlook to provide shaded seating. The overlook is cantilevered to minimize site disturbance to the

riparian corridor below. Selective trees would be removed to allow for 180 degree views up and downstream of the river. Built-in seating allows mixed-use of this space as an outdoor learning center.

Figure 6.22 – Potential Scenic Overlook and Interpretive Area at the Meeting with the French Broad River

